

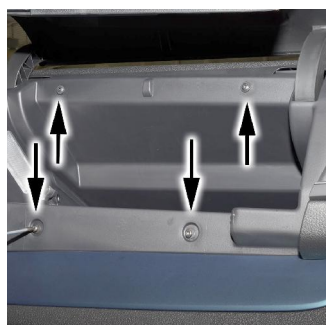

Art.-Nr.: 2870 / 2875
item#

Peugeot Traveller / Toyota Proace Verso / Citroen Spacetourer 2016-



 Originalschrauben lösen

 Unscrew original screws



 Ablagefach entfernen
Verkleidung vorziehen
Bitte benutzen Sie nur ein Kunststoff-Werkzeug!

 Remove storage compartment
Pull cover forward
Please use only plastic tools!

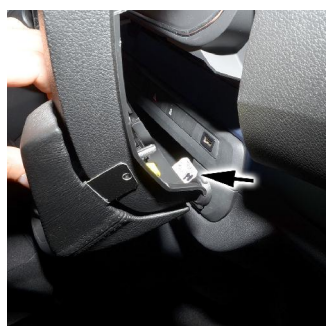

 Konsole wie abgebildet positionieren
Unteres Blech umbiegen

 Position console as illustrated
Bend lower metal plate



 Oberes Blech umbiegen
Verkleidung mit der Konsole wieder montieren

 Bend upper metal plate
Reinstall cover together with console

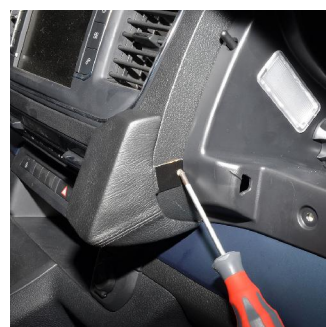

 Beiliegende Schraube ins rechte Blech eindrehen
Ablagefach wieder montieren

 Install enclosed screw into right metal plate
Reinstall storage compartment



Änderungen vorbehalten Subject to change

Art. 2870 / 2875

Peugeot Traveller / Toyota Proace Verso / Citroen Spacetourer 2016-

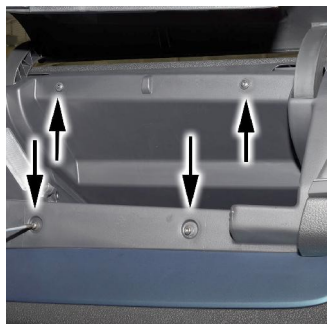

Desserrez les vis originales



Suelte los tornillos originales



Démontez le casier
Avancez la couverture
Veuillez n'utiliser qu'un outil de matière plastique



Desmóntese el compartimiento
Tire el revestimiento hacia delante
Use sólo herramientas de plástico!

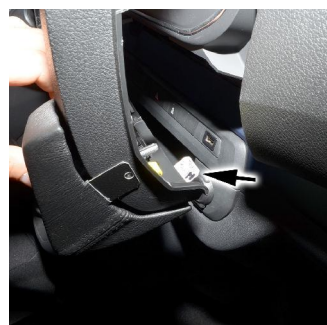

Positionnez la console comme illustré
Tordez la tôle inférieure



Posicione la consola como mostrado
Tuerza la chapa inferior

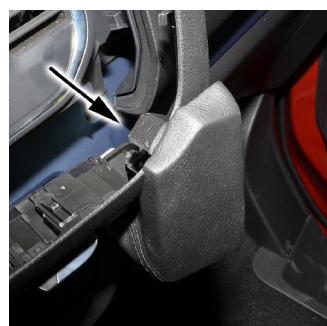

Tordez la tôle de dessus
Réinstallez le revêtement avec la console



Tuerza la chapa arriba
Reinstale el revestimiento junto con la consola

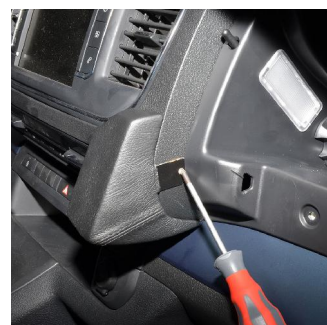

Vissez la vis jointe dans la droite tôle
Montez de nouveau le casier



Instale el tornillo adjunto en la chapa derecha
Reinstale el compartimiento de archivo



Art. 2870 / 2875

Peugeot Traveller / Toyota Proace Verso / Citroen Spacetourer 2016-

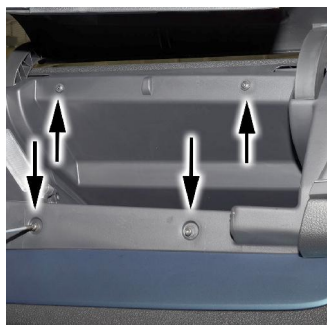

Originele schroefen losdraaien



Poluzowac oryginalna srubes



Kastje verwijderen
Binnenwerk naar voren halen
Alleen plastic gereedschap gebruiken alstublieft!



Otworzyć kieszonkę
Tapicerkę do przodu zdemontować
Proszę używać tylko narzędzi z tworzywa sztucznego.

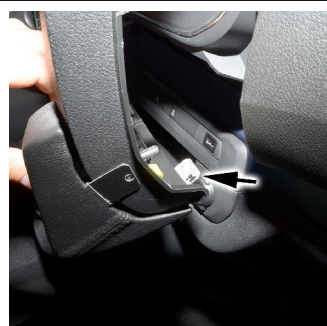

Konsole zoals afgebeeld positioneren
Onderste metalen plaat ombuigen



Uchwyt umieścić jak na przedstawionym zdjęciu.
Dolna blaszka zagiąć



Tuerza la chapa arriba
Reinstale el revestimiento junto con la consola



Górna blaszka zagiąć
Osłone z konsola ponownie zamontować

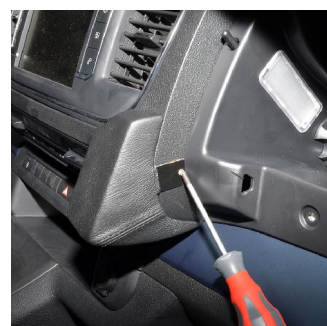

Bijgevoegde schroef in de rechte plaat draaien
Aflégvak weer monteren



Zalączona śruba w prawa blaszke wkręcić
Kieszon ponownie zamontuj

